

Type: P9625

Definite Time (DT) Overcurrent Relay

- True R.M.S. measurements
- Individual Trip Level adjustment for each phase
- Adjustable Delay setting
- Test and Reset button for simulating and clearing of fault condition
- Red LED indication of which phase has been triggered
- Red LED indication of actual tripped condition
- Green LED indication for Auxiliary power supply presence
- Microprocessor based (self checking) with non-volatile memory
- Terminals suitable for 2 x 2.5mm² wires (complete with protective cover)



Dims:
W x H. 96 x 96mm (front)
W x H. 89.5 x 89.5mm (main body)
L. 107mm

PRESENTATION

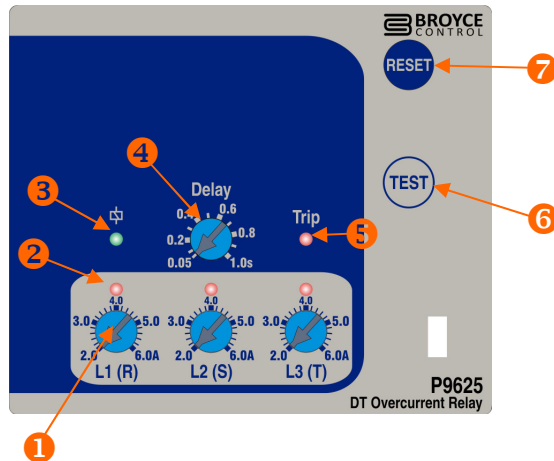

- | | |
|---|------------------------------|
| 1. "Phase" trip adjustment* | 5. "Trip" red LED indication |
| 2. "Phase" trip level exceeded red LED indication | 6. "TEST" button |
| 3. "Power supply" green LED indication | 7. "RESET" button |
| 4. "Delay" adjustment* | |

* accessible only when the front cover is open

GENERAL OVERVIEW

The P9625 (from the P9600 series family of IDMT/DT relays) is a microprocessor based relay designed to monitor and detect Overcurrents in 3-phase applications. Typically the P9625 is wired in conjunction with external current transformers (1 per phase) of the feeder to be protected.

The adjustments and indicators are laid out such to help the user during set-up and fault finding. The adjustment for the L1 (R) for example has its corresponding red LED positioned above it so it is clear as to which phase this LED relates to. Adjustment and LED operation is explained further on the next page.

The adjustment for the **Delay** is a global adjustment that is connected with any one phase that exceeds the set threshold and delays the relay from energising.

A Test mode is provided (also accessible with the tamperproof transparent cover closed) to confirm the correct operation of the internal relay. The relay will energise when the "TEST" button is pressed and de-energise when the "RESET" button is pressed.

OPERATION

When an Overcurrent occurs in one of the phases and the level of current exceeds the trip threshold, the corresponding red LED above the adjustment illuminates. The time out then commences and the relay energises after the delay has run. The red "Trip" LED will then flash indicating a tripped condition.

If the fault current has been removed, pressing the "RESET" button will return the relay back to normal operation. The red LED's will then extinguish.

In the event of an Overcurrent condition, the basic sequence of events is shown below.

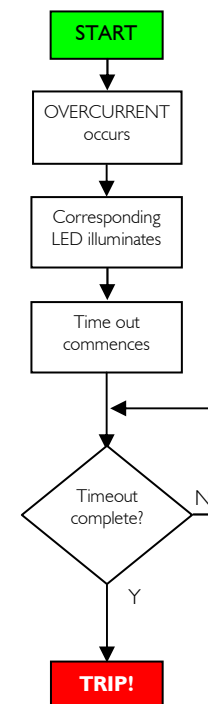

• INSTALLATION



Installation work must be carried out by qualified personnel.

- **BEFORE INSTALLATION, ISOLATE THE SUPPLY. THIS PRODUCT IS DESIGNED TO CONNECT TO SEVERAL TYPES OF CIRCUITS. ENSURE ALL ARE ISOLATED**
- Remove the P9625 from the packaging.
- Lift the raised part of the side clip in order to remove from the housing. Carry this out on each side.
- Insert the P9625 into the panel cut-out and fit the side clips back on to the housing.
- Slide the clips towards the front of the unit until they come in to contact with the reverse of the panel. The unit is now secured in place.
- Connect wires to the rear terminals as required.
- The P9625 is now ready for powering and setting.

☞ The front window of the P9625 is supplied with a clear protective film which can be removed as and when necessary.

• NORMAL OPERATION

- Apply power to the unit and the green "Power supply" LED will illuminate.



• TEST MODE

- Press and hold the **TEST** button and the relay will energise after the delay period. All red LED's will illuminate.
- Release the **TEST** button, the relay will remain energised and all red LED's lit.
- Press the **RESET** button to de-energise the relay. All red LED's will extinguish.

☞ Testing should be carried out on a regular basis to check the integrity of the P9625.



DO NOT use this product to provide a means of isolating circuits in order to work on when placed in the "TEST" mode. This should only be done by means of operating isolators, circuit breakers or other methods of removing power in this application.

• SETTING & OPERATION

Setting of the P9625 is carried out using the 4 potentiometers located behind the transparent cover.

1. Delay



The adjustment for "Delay" defines the delay period between exceeding a trip threshold on any of the phases and the relay energising.

The delay can be set from 50mS to 1.0s.

2. Trip threshold

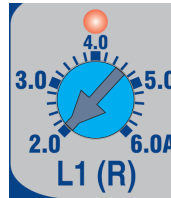

Individual adjustments for the trip threshold allow the user to set each phase independently of each other. When the threshold is exceeded on any phase due to an Overcurrent condition, the corresponding red LED above the adjustment illuminates indicating activity. When tripping finally occurs, the red "Trip" LED will then flash.

In response to an Overcurrent condition (on any phase):

Status	Phase LED*	Trip
Normal	●	●
Phase triggered	☀	●
Tripped	☀	☀

In response to Test and Reset button operation:

Button press	Phase LED*	Trip
TEST	☀	☀
RESET	●	●

* Can be L1 (R), L2 (S) or L3 (T)

Key:

- LED off ●
- LED on ☀
- LED flashing ☀

• TECHNICAL SPECIFICATION

Supply voltage U_n (1, 2):	115VAC $\pm 15\%$ 230VAC $\pm 15\%$ <i>(Voltage should be specified at time of ordering)</i>
Rated frequency:	50/60Hz
Isolation:	Over voltage cat. III
Rated impulse withstand voltage:	4kV (1.2 / 50 μ S) IEC 60664
Power consumption:	3W max.
Rated current input In:	5A (directly connected)
Rated frequency:	50Hz
Burden:	<0.4VA @ In
Overload:	4 x In (continuous)
External CT's (9, 10, 11, 12, 13, 14):	Class P recommended. (with 5A secondary)
Overcurrent settings:	
Trip threshold:	2.0 – 6.0A (40 – 120%)
Time Delay:	0.05 – 1.0s
Pick up value:	+2% of trip setting
Accuracy:	
Protection thresholds:	$\pm 5\%$
Response time:	$\pm 5\%$ (with a minimum of 50mS)
Repeat accuracy:	$\pm 0.5\%$ @ constant conditions
Ambient temperature:	-10 to +60°C
Relative humidity:	+95% (non-condensing)
Output: (RL1 - 3, 4, 5):	1 x SPDT relay
Output rating:	AC1 250V 8A (2000VA) AC15 250V 5A (1250VA) DC1 25V 8A (200W)
Electrical life:	$\geq 150,000$ ops at rated load
Dielectric voltage:	2kV AC (rms) IEC 60947-1
Rated impulse withstand voltage:	4kV (1.2 / 50 μ S) IEC 60664

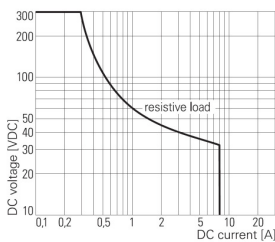

Max. DC Load Breaking Capacity

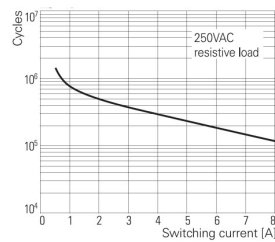

Electrical Endurance

Housing:	Flame retardant Lexan
Protection:	IP55 / IP20 (rear)
Weight:	$\approx 590g$
Mounting:	Panel mounting. Cut-out = 91 x 91 mm ($\pm 0.5mm$)
Max. panel thickness:	12mm
Terminal conductor size:	0.05 - 2.5mm ² (30 - 12AWG)
Recommended tightening torque:	10in lb (1Nm)
Wire stripping length:	0.24 – 0.30in (6 – 7.5mm)
Approvals:	Conforms to IEC, CE and  and RoHS Compliant. EMC: Immunity: EN/IEC 61000-6-2 Emissions: EN/IEC 61000-6-4 Generic: IEC 60255-26 (EMC), IEC 255-3, IEC 60255-151

() Bold digits in brackets refer to terminal numbers on the rear of the unit.

Options:

The P9600 range also includes individual Overcurrent or Earth fault relays available with either IDT or IDMT tripping characteristics. Please refer to separate data sheets.

• CONNECTION DIAGRAM

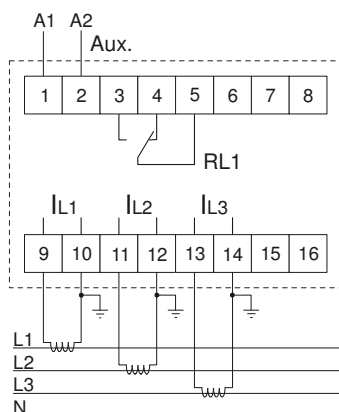

• DIMENSIONS

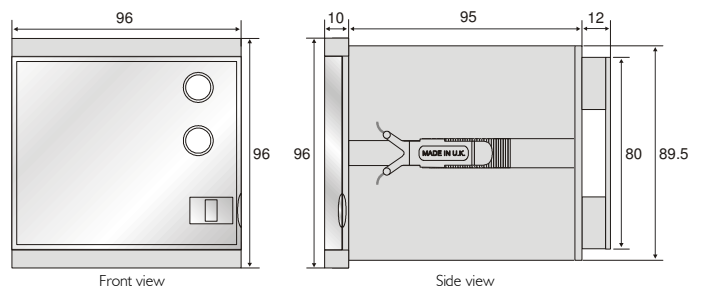

All dimensions are in mm.